

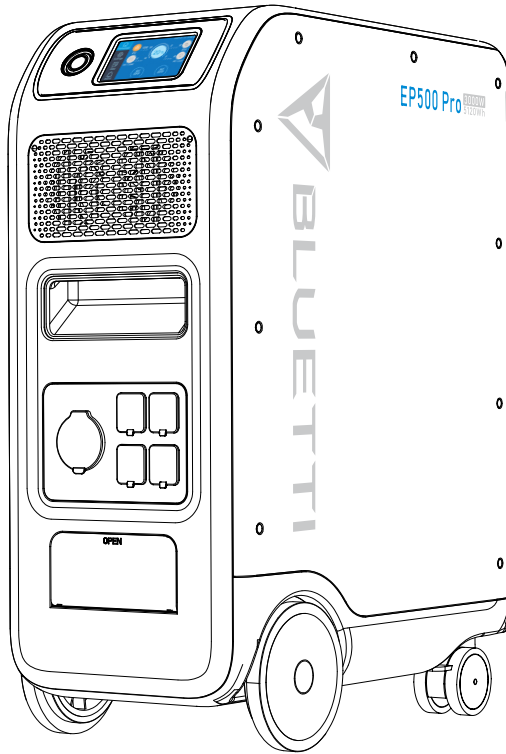

EP500Pro Power Station

Please read this manual before use and follow its guidance. Keep this manual for future reference.



User Manual

Please read this manual before use and follow its guidance. Keep this manual for future reference.

Contents

01. EP500Pro Introduction	01
02. General Safety Instructions	02
03. What`s in the Box	05
04. APP.....	07
05. Features of EP500Pro	11
06. Startup & Power off	12
07. User Interface	13
08. How to Recharge EP500Pro (INPUT)	20
09. Discharge (OUTPUT)	27
10. UPS	30
11. Split Phase Function	35
12. Technical Specification	38
13. Storage and Maintenance	40
14. Troubleshooting	41
15. FAQ (Frequently Asked Questions)	46
16. Declaration	48

01. EP500Pro Introduction

1.1. Introduction

- BLUETTI is proud to take the energy storage world by storm with the release of its first home energy storage system series - the EP500Pro with four smooth-rolling transport wheels, the EP500Pro was not designed to be a large solar battery mounted on the wall or in the garage. The BLUETTI EP500Pro was not only designed to be a "No Installation Needed", plug-and-play mobile UPS that can easily be moved to the desired location when necessary, but also a power backup system that ensures emergency power when a power outage occurs.
- The EP500Pro system uses a dual-core controller (ARM controller + DSP controller) which combines digital and analog signals perfectly to manage and control the MPPT module, the AC Inverter module (Bidirectional topology, supporting AC reverse fast charging), the DC-to-DC module, and the built-in battery pack.
- EP500Pro integrates a solar charge controller, AC charge controller, AC inverter, lithium battery, and battery management system into one, converts clean and environmentally friendly solar energy and grid electricity into clean power sent to all of your home appliances.
- EP500Pro Power Station system is suitable for areas with energy shortage or unstable power, and also for the power supply or disaster emergency in areas without stable power supply such as isolated islands and borders.

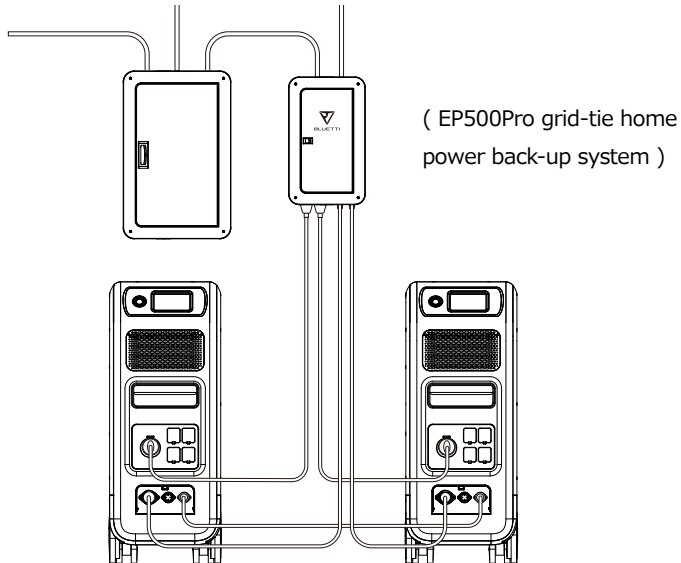

1.2. Abbreviation

- BMS: Battery Management System
- MPPT: Max. Power Point Tracking
- SOC: State of Charge
- UPS: Uninterruptible Power Supply
- AC: Alternating Current
- DC: Direct Current
- PV: Solar Panel(s) Charging(Photovoltaic)
- Grid: Home Power Supplied by Utility
- T500: 500W additional charger
- DOD: Depth of Discharge
- ECO Mode: A power - saving mode for the EP500Pro, the AC output ports are automatically turned off if the load is less than 30W over a span of 4 hours.

02. General Safety Instructions

Please read this manual before operating.

- A licensed electrician is required to install the grid-tie power system as involves connecting the wires of critical equipment from your main electrical box to the BLUETTI Sub Panel (Optional Purchase).
- DO NOT place EP500Pro near heat sources. It is prohibited to place and operate EP500Pro in an environment with flammable, explosive gas, or smoke.
- DO NOT attempt to replace the internal battery or any other components of EP500Pro by anyone other than authorized personnel. There are no user-serviceable components in the package.
- DO NOT operate in wet conditions. If EP500Pro becomes wet, please let the unit dry completely before using.
- Please ensure proper ventilation while in use and do not obstruct fan openings. Inadequate ventilation may cause permanent damage to the equipment.
- DO NOT stack anything on top of the power station either in storage or while in use.
- DO NOT move the unit while operating as vibrations and impacts may lead to poor connectivity to hardware inside.

● **Warning:**

- DO NOT insert foreign objects into any ports of EP500Pro (both AC & DC & ventilation holes). EP500Pro generates the same potentially lethal AC power as a household wall outlet. Please use EP500Pro carefully and keep children away from it.
- If necessary, only the dry powder fire extinguisher is suitable for the product.
- For safety purposes, please use only the original charger and cables designed for the equipment. We are not liable for damage caused by third-party equipment and may render your warranty, invalid.

2.1. Installation (for grid-tie system)

- Before touching any conductor surface or terminal, measure the voltage of the contact point to confirm that there is no danger of electric shock.
- After the equipment is installed, empty packaging materials such as cartons, foam, plastic, cable ties, etc. should be removed from the equipment area.
- Except for those who operate the equipment, please keep others away from the equipment.
- The handling of any tools being used needs to be insulated and protected from shock, or use insulated tools.
- All wiring holes need to be sealed. Use fire-resistant mud to seal the wiring holes that have been routed and use the cover of the cabinet.
- It is strictly forbidden to alter, damage or obscure the logo and nameplate on the equipment.
- When installing the device, please use the appropriate tools to tighten any screws.
- Live operation is strictly prohibited during installation.
- Before operation, the equipment should be secured onto a floor or other stable objects, such as walls or possibly mounting brackets if needed.
- It is prohibited to clean any electrical components inside and outside the cabinet with water.
- Do not change or modify the structure, installation sequence, etc. of the equipment without prior authorization.

2.1.1. Personal Safety

- The personnel responsible for the installation and maintenance of the equipment must first undergo rigorous training to understand various safety precautions

and grasp the correct method of operation.

- Trained personnel: personnel who have undergone corresponding technical training and have the necessary experience to be aware of the danger that may be brought to him during the operation, and can take measures to reduce the danger to himself or other personnel to at the lowest limit.
- The replacement of equipment or parts (including software) must be done by professionals or authorized personnel.

2.1.2. Personnel Requirements

- The personnel responsible for the installation and maintenance of the equipment must first undergo rigorous training to understand various safety precautions and grasp the correct method of operation.
- Trained personnel: personnel who have undergone corresponding technical training and have the necessary experience to be aware of the danger that may be brought to him during the operation, and can take measures to reduce the danger to himself or other personnel to at the lowest limit.
- The replacement of equipment or parts must be done by professionals or authorized personnel.

2.1.3. Anti-static requirements

When installing the sub-panel with your main panel, you must wear anti-static gloves or an anti-static wrist strap before touching the device. The other end of the anti-static wrist strap should be properly grounded. Do not touch any bare components directly with your hands.

2.1.4. Drilling

The following safety precautions are to be considered when drilling holes on the wall or into the ground:







- It is strictly forbidden to drill holes into the equipment. Drilling will alter and damage the electromagnetic shielding performance of the equipment, internal components, and cables. The risk of metal shavings entering the device can cause short circuits on the circuit board.
- Wear goggles and protective gloves when drilling holes.
- The equipment should be shielded and protected during the drilling process to prevent debris from falling into the equipment. After drilling, any debris which may have landed on the equipment should be removed and cleaned.

2.2. Installation environment requirements

- When the equipment is running, please do not block the vents or the heat dissipation system in order to prevent high temperatures and/or fires.
- The equipment should be installed in an area away from liquids. It is forbidden to install it near or below water pipes, air outlets and other locations that are prone to water condensation.
- It is forbidden to install the unit underneath pipes, windows or other similar areas that are prone to water leaks in order to prevent liquids from entering into the equipment. Failure to do so may result in a short circuit.
- If liquid is found inside the device, user must turn off the power immediately.
- The equipment room must be properly insulated and the walls and floors must be damp-proof.







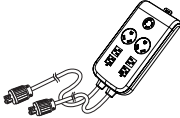

03. What`s in the Box

Standard Accessories

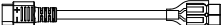
No.	Picture	Category	Quantity
1		EP500Pro Power Station	1
2		AC Charging Cable Charging EP500Pro via wall outlet	1
3		PV Charging Cable Charging EP500Pro via solar power	1
4		User Manual Please keep it for future reference	1
5		Warranty Card For after-sale service	1
6		Certificate of QC PASS	1

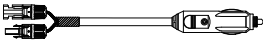
Additional Purchase Accessories

Sold on BLUETTIPOWER.COM

No.	Picture	Category
7		<p>Split Phase Box Pro (P030A) To double the capacity, power of output and voltage.</p>
8	 <p>12V/30A XT60 to Aviation Plug</p>	<p>12V/30A RV Cable For 30A DC Output.</p>
	 <p>XT60 to SPC45 To support DC power supply for RV.</p>	
9		<p>Generator Charging Cable Charging EP500Pro via generator.</p>
10		<p>Lead-acid Battery Charging Cable Charging EP500Pro via Lead-acid battery.</p>
11		<p>Car Charging Cable Charging EP500Pro with cable No3.</p>
12		<p>T500 500W Adapter Additional 500W AC charger.</p>
13		<p>AC Charging Cable for Split Phase Charging two EP500Pro connected in split phase mode via wall outlet.</p>
14		<p>PV Drop Down Module (D300S) Charge EP500Pro via roof/rigid panels.</p>
15		<p>Sub Panel Integrate the power station to your home circuit as backup UPS.</p>

04. APP

Please make sure the state of Bluetooth & Wi-Fi settings is “ON” before connecting EP500Pro with BLUETTI App.

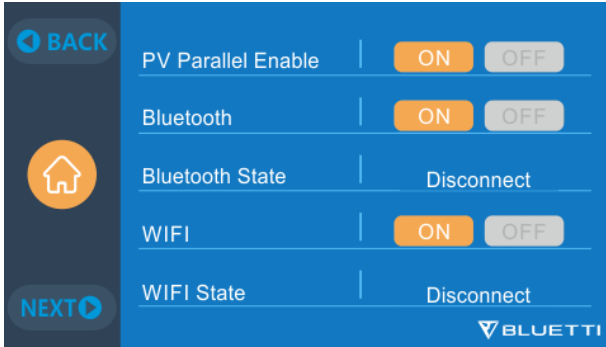

(Homepage - Settings - Next - Next)

Step 1:

- Please search “BLUETTI” on the App Store (for IOS devices) or Google Play (for Android devices) to download the BLUETTI App to remotely control your EP500Pro.
- EP500Pro can be controlled via Bluetooth or Wi-Fi. To activate the remote control, please launch the BLUETTI App, and click the “**LOGIN**” icon to “**REGISTER**” your BLUETTI account and fill with your related information to continue.

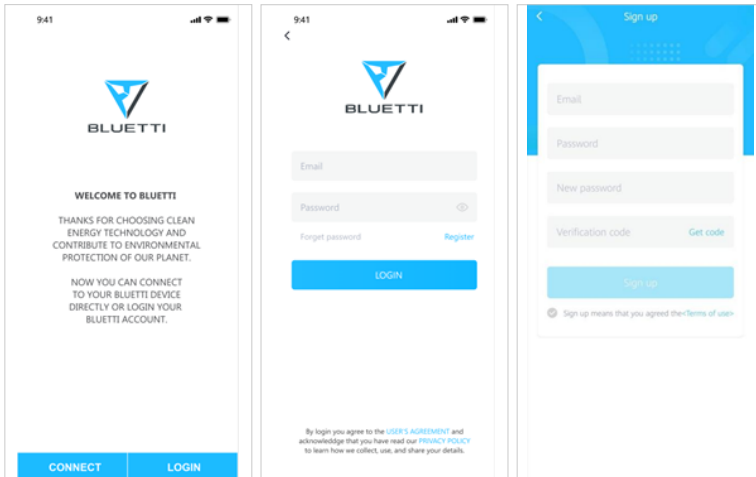

- Check your email account you used in the BLUETTI App for the verification code sent from BLUETTI and fill in the activation code located within the email to activate your BLUETTI account.

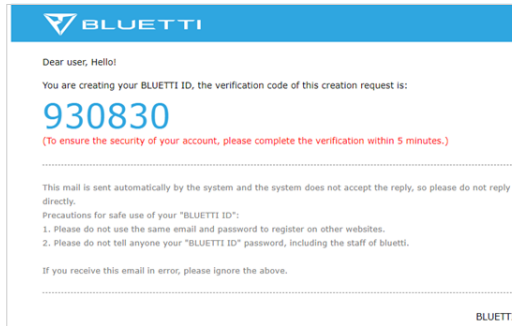

Step 2 :

- Scan the unique QR code on EP500Pro to add the unit on the available device list on the App, and fill it with the password of your 2.4G Wi-Fi network to activate the communication function of EP500Pro for data syncing.

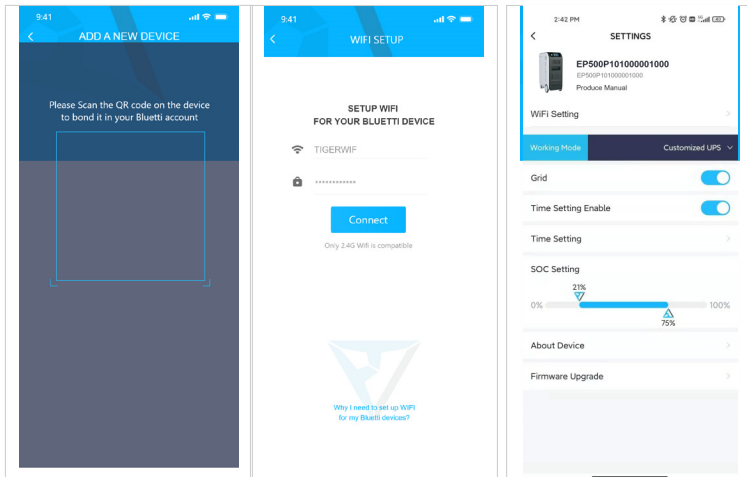

- For Bluetooth Connecting, tap "CONNECT" at the homepage to connect EP500Pro with your phone via Bluetooth, select the SN number of your devices. Please press "settings-product info" on EP500Pro to view the SN number of your unit.

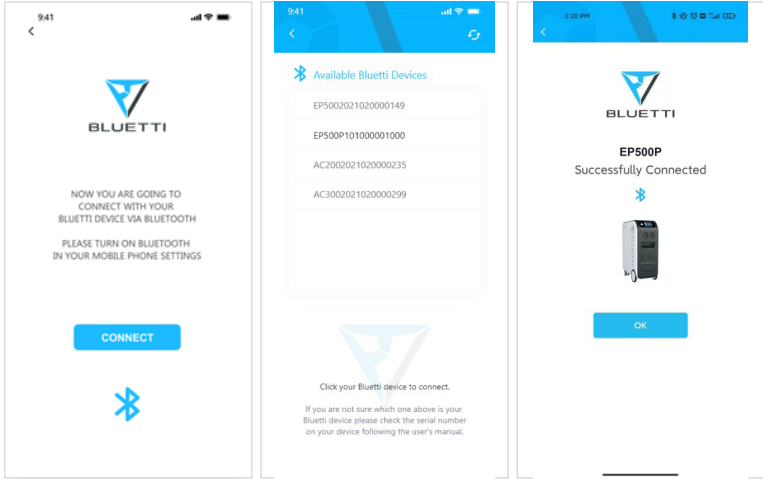

- The basic information can be viewed after the unit is connected with App successfully. Press “gear icon” to customize the current working mode and parameters of your EP500Pro under “Settings”.

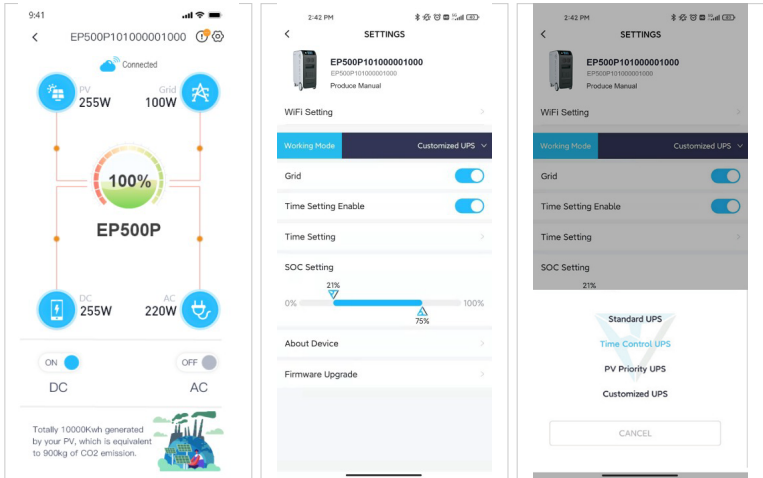

- The BLUETTI App supports a “Firmware Update” function which allows access to the latest software upgrades for continued features, improvements and fixes.

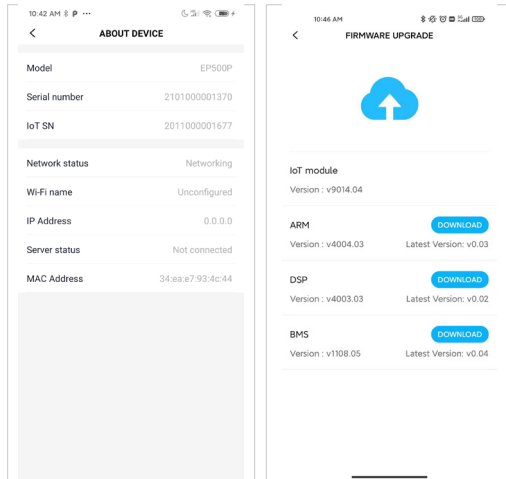

Note: Please keep your phone 5m/16.4ft within the EP500Pro for a better connection during update.

Also, if BLUETTI APP fails to connect to the Internet. Tap "Settings" at the homepage of your phone and scroll down until the BLUETTI App shows up(IOS). Tap "Settings" on homepage of your phone, tap "Application Management" and select BLUETTI(Android). Tap the BLUETTI icon and verify that "Wireless and Data" permissions are enabled.

User cannot turn on EP500Pro via BLUETTI App.

05. Features of EP500Pro

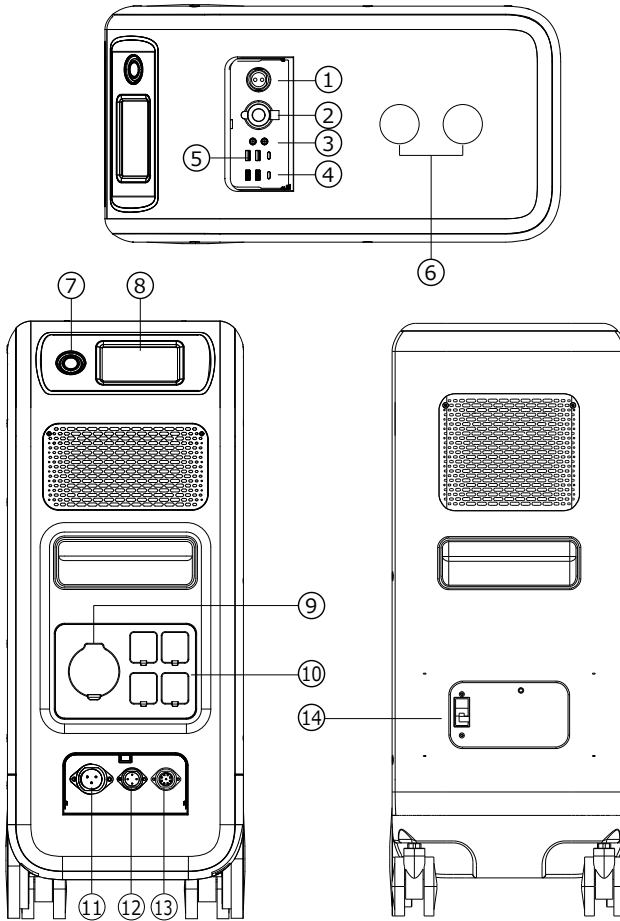

- 01 12V/30A Port
- 02 12V/10A Cigarette Lighter Port
- 03 12V/10A DC5521 Port
- 04 USB-C (PD3.0 protocol supported)
- 05 USB-A
- 06 Wireless Charging Pad
- 07 Power Button

- 08 Touchscreen
- 09 AC Output Port(30A MAX)
- 10 AC Output Port(20A MAX)
- 11 AC Input Port
- 12 DC1/DC2 Input Port
- 13 Communication Interface
- 14 Main Battery Switch

06. Startup & Power off

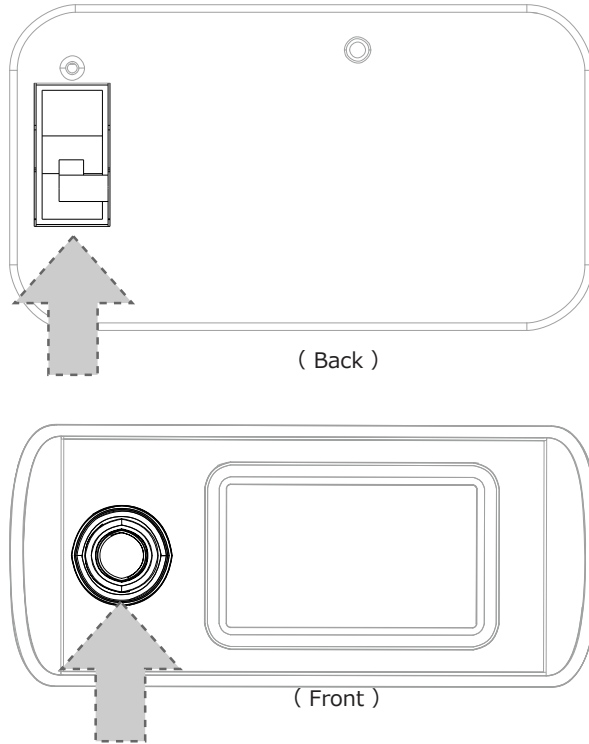

- Turn on the main power switch located on the back of EP500Pro.
- Power On: Long press the power button. The power button indicator will illuminate.
- Power Off: Long press the power button. The power button indicator light will turn off.
- EP500Pro will turn on automatically from Power Off status when either grid charging and/or PV charging is applied on.
- DC and AC power switch are accessible on the Touchscreen. Press the "DC ON/OFF" button and/or "AC ON/OFF" button to turn ON/OFF the DC/AC output.

07. User Interface

7.1. Main Interface

Tip:

The LCD resistive touchscreen, recommended to press lightly with the edge of your fingernail until it "beeps" when it registers a press. **(NOTE: Touchscreen sounds can be disabled in the Settings menu).**

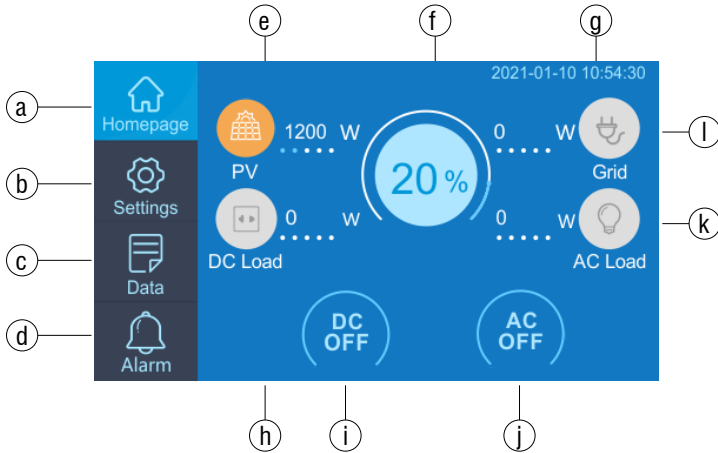

- a. Homepage
- b. Settings
- c. Data
- d. Alarm
- e. PV Charging Information
- f. BMS Information
- g. Date/Time
- h. DC load Information
- i . DC ON/OFF
- j . AC ON/OFF
- k. AC load Information
- l . AC Charging Information

7.2. Settings

- User can customize the working mode of EP500Pro and tweak the equipments parameters such as language, voltage, frequency, current (UPS Grid -Tie Mode), working type, date/time, etc.
- Tap the Settings Button on the homepage to enter the setting interface.

7.2.1. AC Output Voltage & Frequency

- NOTE: Please check the output voltage, frequency, and other parameters BEFORE using EP500Pro for the first time. The EP500Pro 100-120V AC version cannot be set to 220-240V AC output.
- The Output frequency and voltage can only be tweaked when the AC is OFF (tap the AC icon at homepage to turn off AC output if it's ON).
- The list of standard output voltage and frequency in 5 regions or countries. You may tap on the screen to set the parameters as needed.
 - JP Output: 100V/50Hz or 60Hz
 - AU Output: 240V/50Hz
 - US Output: 120V/60Hz
 - EU/UK Output: 230V/50Hz

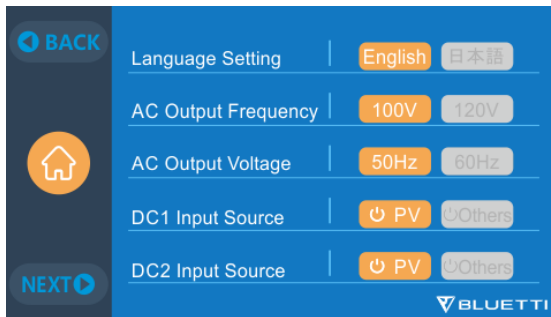

7.2.2 DC Input Source

DC Input Source: EP500Pro integrates dual MPPT and separates the DC input source into DC1 and DC2 in parallel. DC1 indicates the first group of DC input source as the labels written on MC4 plug of PV charging cables:

DC1 PV+ and DC1 PV-, DC2 PV+ and DC2 PV-. DC1/DC2 consist of both positive pole and negative pole of the MC4 plugs.

Both DC1 and DC2 input source can be set on touchscreen: (Homepage - Settings - DC1/DC2 Input Source).

Can be set on screen:
(Homepage - Settings - DC1/DC2 Input Source)

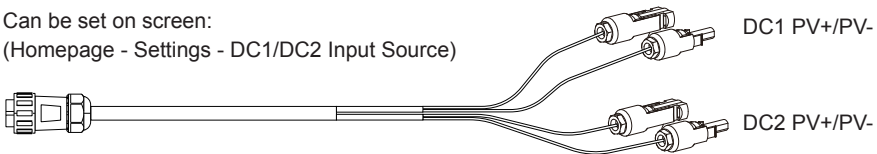

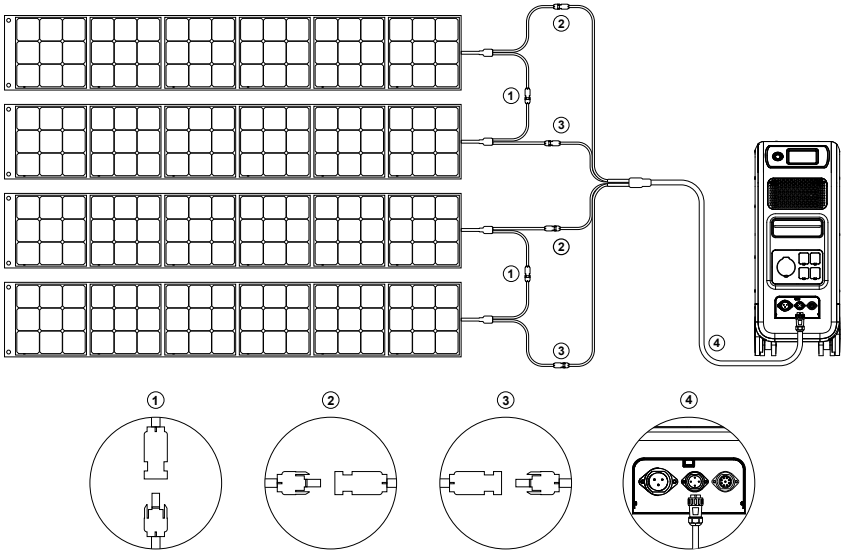

- a, Connect your solar panels in series into PV charging cable.
- b, Plug the Aviation plug into the middle input port(CP2) on EP500Pro.

7.2.3. Language Setting & ECO Mode

Press “English” or “Japanese” icon to set as the default system language to be displayed on your EP500Pro.

ECO: When ECO is turned ON, if the AC output load is less than 30W for 4 hours,the AC ports will be shut off for power-saving.

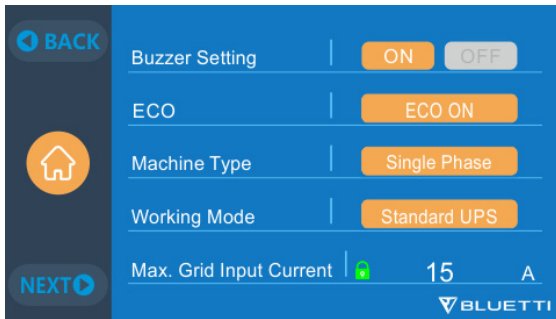

7.2.4. Machine Type (for split phase setting, exclusive for 100-120V Version)

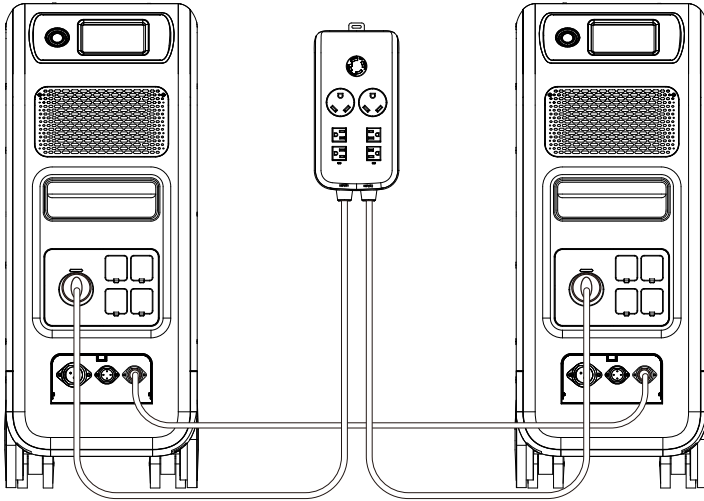

Please turn to **Chapter11** for detailed installation.

7.2.5. Working Mode(Homepage - Settings - Next - Working Mode)

Tips: EP500Pro will be set as the Standard UPS Mode as default.

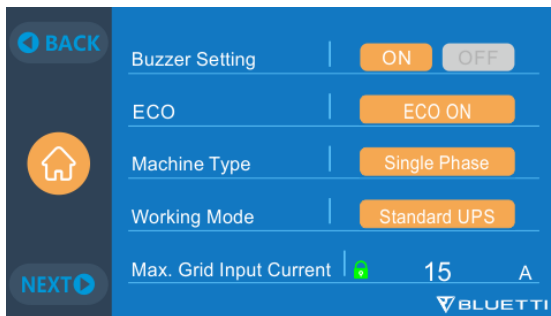

There are altogether four working modes you can select in settings:

Standard UPS Mode: Default working mode(Offline mode).

PV Priority Mode: Recommended for areas in stable power supply.

Time Control Mode: Suitable for areas with peak and off-peak time-of-use rates for money saving.

Customized Mode: Customized the parameters for a better user experience.

Detailed UPS Mode setting please check **Chapter 10 UPS**.

7.2.6. Max. Grid Input Current

- Please check the specification of your grid, sockets, connections, wires, etc. to determine the maximum allowable current that can be drawn by the EP500Pro. BLUETTI is not liable for any damages, injuries, or any other legal responsibility incurred directly or indirectly from changes made to this setting.
- Max. Grid Input Current: limit the Max. current of the tied grid, when the current exceeds the preset value, EP500Pro will take charge to be the power source of the circuit.

Note: Only take effect when EP500Pro has been connected into grid. The value is preset at 15A.

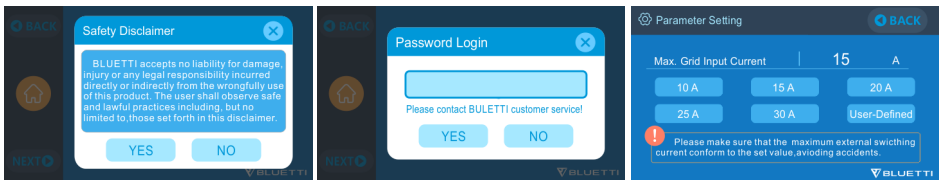

7.2.7. Date and time & Touch Sound & Backlight Brightness

- Tap each respective date and time setting in order to set the date and time as applicable to your local time zone.
- Tap to Enable/Disable touch sounds.
- You may change the Backlight Brightness of the Touchscreen LCD by using the slider on the screen.

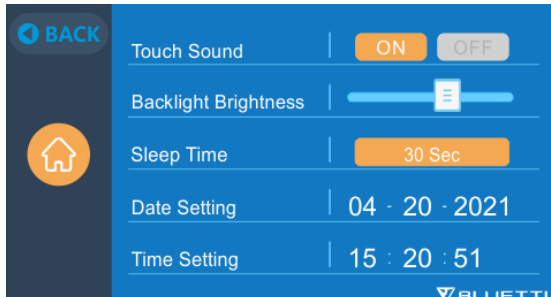

7.2.8. Bluetooth & Wi-Fi Connection

The Bluetooth and Wi-Fi connection can be turned ON or OFF by tapping the ON and OFF icon for either function.

User cannot connect EP500Pro to BLUETTI App when both of the Wi-Fi and Bluetooth function is disabled.

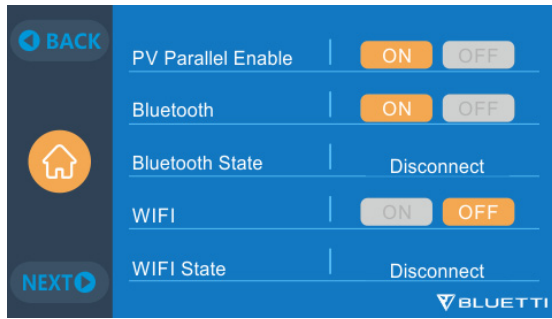

7.3. Data

In the Data section, you may view Product Info, Inverter & Charger Info, BMS Maintenance, and Alarm/Fault History by selecting each respective button.

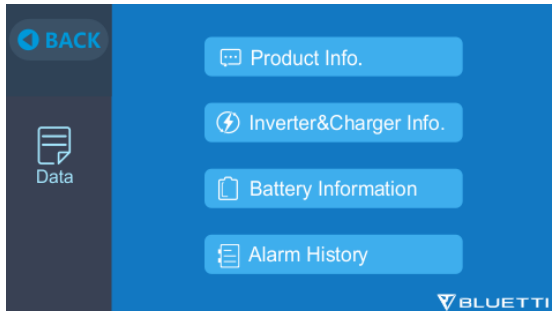

7.3.1. Product Info

- When you select the “Product Info” button, you can view the product model, serial number (SN), control software version, monitoring software version, BMS monitoring software version and display software version.
- The Serial Number (SN) can also be used to pair to BLUETTI APP manually.

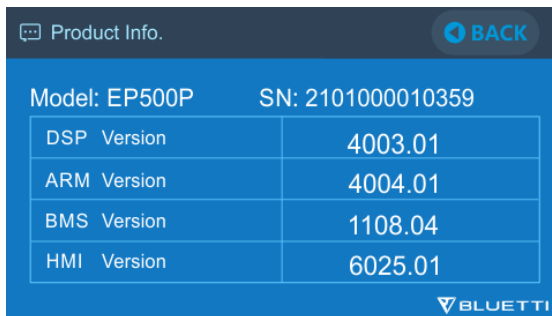

7.3.2. Inverter & Charger Info

By tapping the “Inverter & Charger Info” button, user can view the PV charging,

adapter charging, DC output and AC output working status. This section can also be accessed directly from the shortcut icon on the homepage.

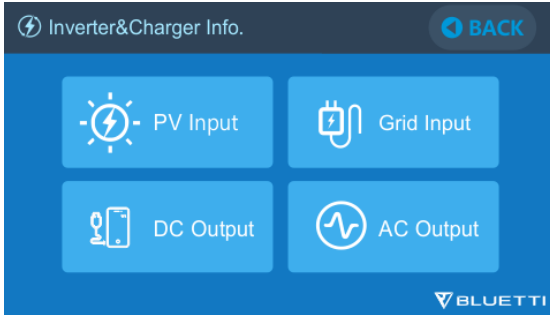

7.3.3. Battery Information

By tapping the “Battery Information” button, user can view the live information of the status of the battery pack. This section can also be accessed directly from the shortcut icon on the homepage.

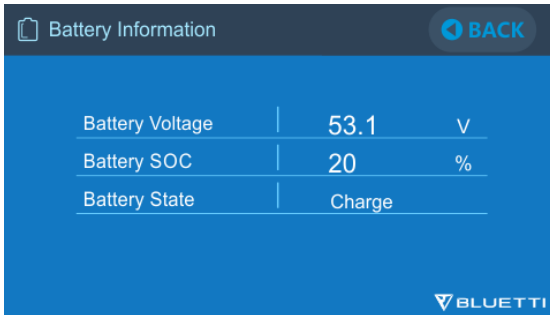

7.3.4. Alarm History

Tap the “Alarm History” button, user can view all the alarm information generated by the machine. User can turn to the Chapter 14 Troubleshooting to check the corresponding solutions.

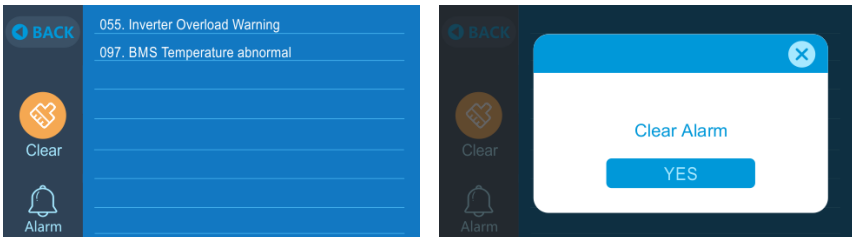

08. How to Recharge EP500Pro (INPUT)

- The EP500Pro includes two charging ports which can be recharged in different methods. They will be covered in three different sections according to which port(s) are being connected.
- The two ports are named as Aviation Charging Port 1 [CP1] and Aviation Charging Port 2 [CP2].

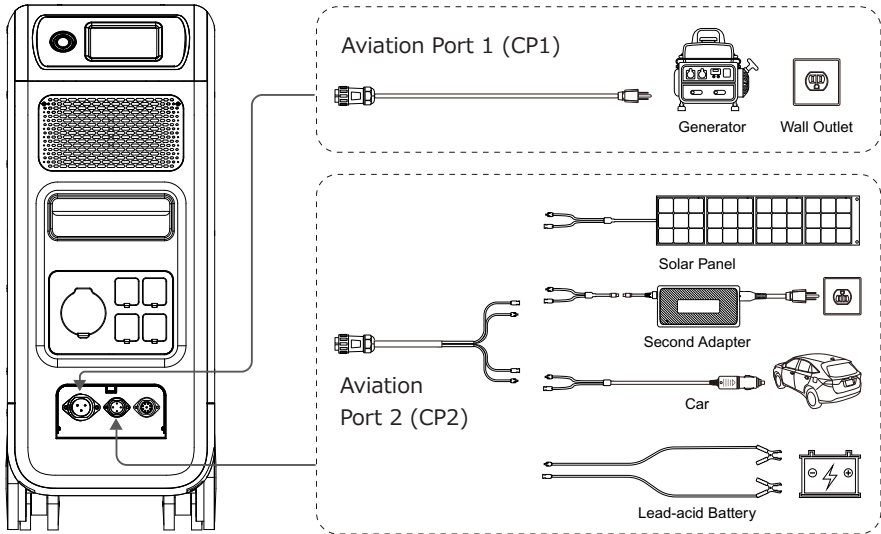

8.1. CP1 (1st Charging Port)

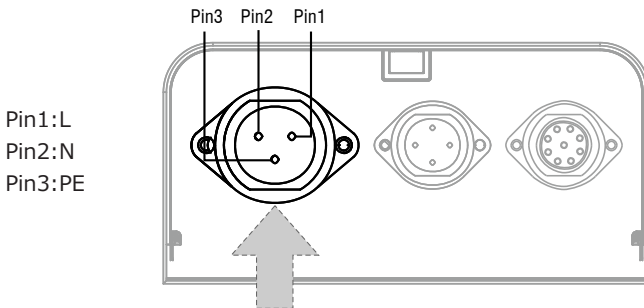

8.1.1. Charging Method 1: From Wall Outlet (by AC charging cable)

Connect the EP500Pro from CP1 via the AC charging cable to the wall outlet

@1500W/100Vac , @1800W/120Vac Max .

The charging process will automatically stop when it reaches 100% capacity. Additionally, you can choose to access the BLUETTI Sub Panel or the L14-30 receptacle, the maximum charging power allowed will be up to 3000W.

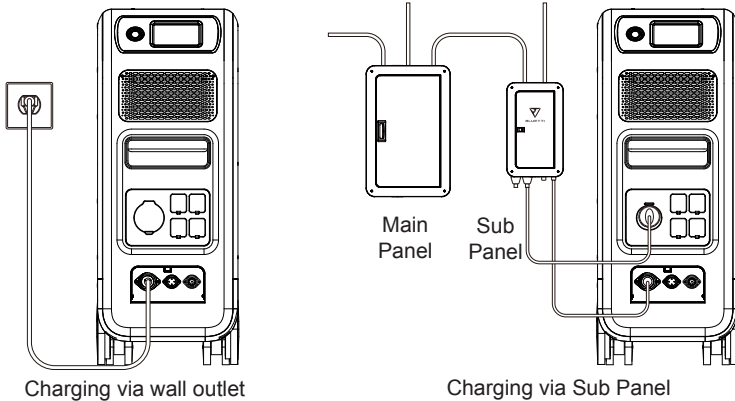

8.1.2. Charging Method 2: From Generator (gasoline, propane, or diesel)

- Connect the EP500Pro from CP1 via the generator charging cable (sold separately) to the AC output of the generator. The charging process will automatically stop when it reaches 100%.
- The required output power of your generator has to exceed the Max. input power of the AC input port of the EP500pro. Also a generator with a pure sine wave output is recommended (e.g. Inverted-based Generators)

Voltage limit:

85-110VAC/JP(100VAC), 102-132VAC/US(120VAC), 207-253VAC/EU/UK/AU.

Frequency limit: 47Hz-53Hz(50Hz), 57Hz-63Hz(60Hz).

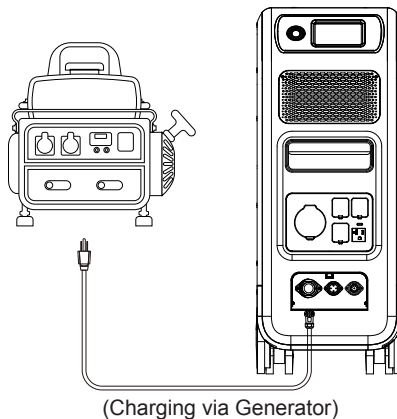

8.2. CP2 (2nd Charging Port)

- Pin1:DC1 PV+
- Pin2:DC2 PV+
- Pin3:DC1 PV-
- Pin4:DC2 PV-

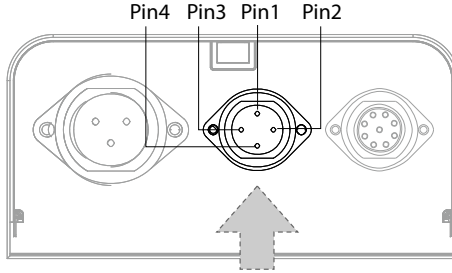

8.2.1. Charging Method 3: Solar Panels (via 4pin aviation-MC4 cable)

- For regular solar panels:

EP500Pro(dual MPPT) supports two PV charging methods with regular portable panels and rigid panels.

Max current for single circuit: 12A.

Voltage Range: 12-150V.

Max. Input Power: 2400W.

- a. User can connect 4-6 pieces of SP200 solar panels to the MC4 ports of solar panels to the MC4-Aviation cable (figure 1/2/3).
 - b. Plug the Aviation plug to the middle input port on EP500Pro (figure 4).
- Enter “Settings” on touchscreen to set DC input source to “PV”.

Note: Select DC1 or DC2 Input Source according to the the certain DC cables (check the label on cable No.3) you are connecting.

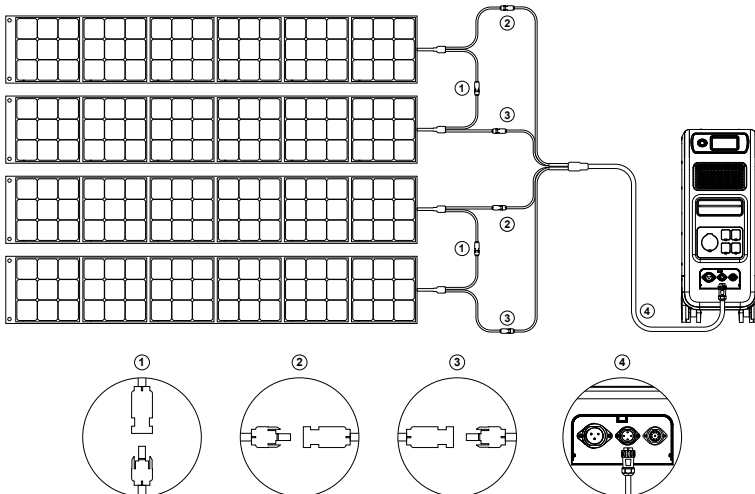

(Easy steps to solar charging)

● **For Roof/Rigid Panels:**

If you choose roof panels to be the solar power source to recharge EP500Pro, connect your roof panel with MC4-Aviation to EP500Pro through PV Step Down Module will finish the installation.

PV Module (additional accessories) is required to drop down the voltage if the open circuit voltage produced by your roof panels exceeds the limit of EP500Pro can handle: 12-150VDC, 12A*2.

This PV module doesn't work with solar panels that have built-in microinverters, and open circuit voltage over 550V.

Please check BLUETTI Youtube channel: BLUETTI Official for detailed instruction video.

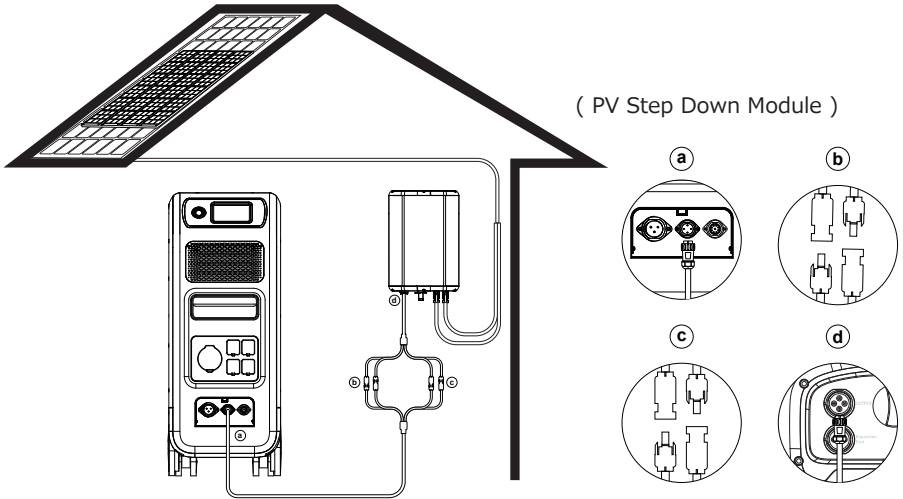

a. DC Output Cable to EP500Pro
b. DC1 poles to PV1 poles

c. DC2 poles to PV2 poles
d. DC Output Cable to D300S

8.2.2. Charging Method 4 :Vehicle Charging

- Turn on EP500Pro.
- Connect car charging cable with MC4 to Aviation cable(cable No.3)
- Plug the car charging cable into CP2 and the cigarette lighter port on your car.
- Enter "Settings" on touchscreen to set DC input source to "Others".

Note: Select DC1 or DC2 Input Source according to the the certain DC cables(check the label on cable No.3) you are connecting.

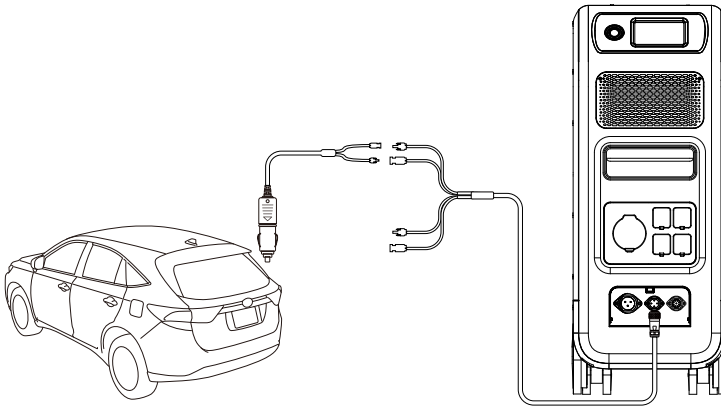

8.2.3. Charging method 5: Lead-acid Battery Charging

- Connect to the positive and negative poles of the battery through the battery charging clamp (pay attention to distinguish the positive and negative poles of the battery, the red pole on battery indicates the positive pole, and the black one for negative pole).

- Enter "Settings" on touchscreen to set DC input source to "Others".

Note: Select DC1 or DC2 Input Source according to the the certain DC cables (check the label on cable No.3) you are connecting.

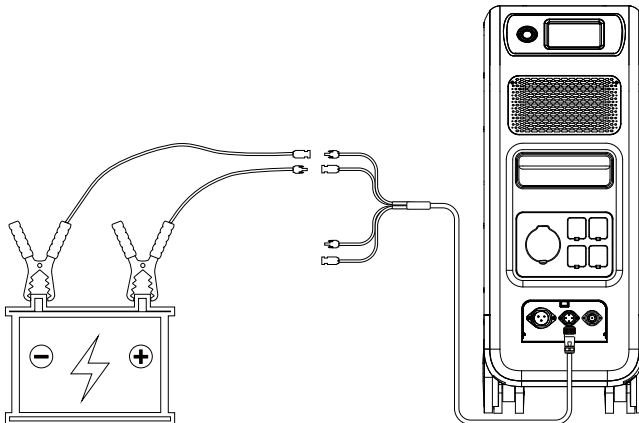

8.3. Dual Charging

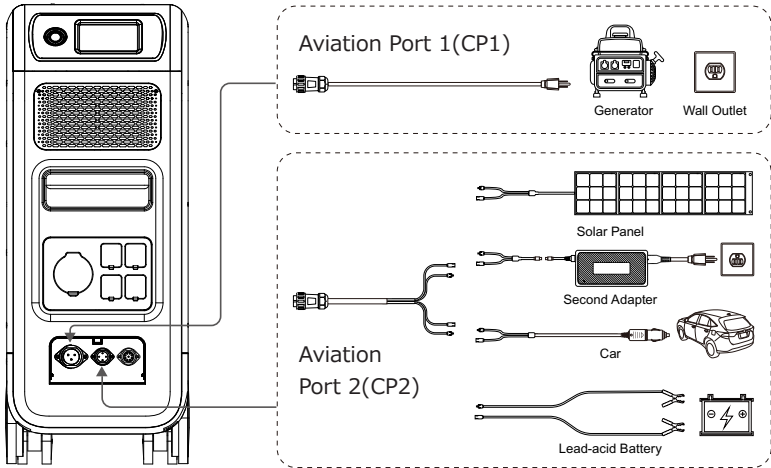

Charging Method 6 : Supports charging the EP500Pro with CP1 and CP2 at same time. You can use any charging methods listed previously, simultaneous, to maximize charging power input.

They are listed here again for your convenience. Select the method for both CP1 and CP2 to Dual Charging.

CP1 Charging Port Select:

- Method 1: GEN charging cable
- Method 2: AC charging cable

CP2 Charging Port Select:

DC Input1:

- Method a: Solar panels(Set DC 1 Input Source as "PV" in "Settings").
- Method b: T500 Adaptor(Set DC 1 Input Source as "Others" in "Settings").
- Method c: 12V/24V Car Charger/Storage battery(Set DC 1 Input Source as "Others" in "Settings").

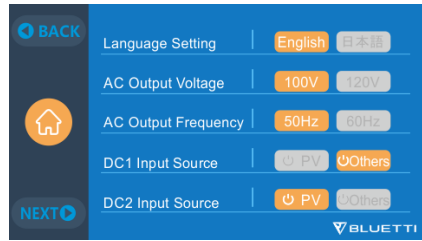
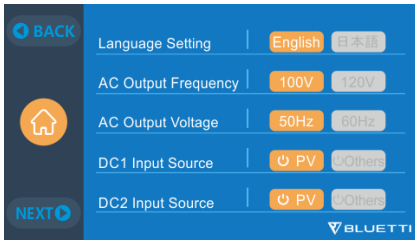

DC Input2:

Method a: Solar panels(Set DC 2 Input Source as "PV" in "Settings")

Method b: T500 Adaptor(Set DC 2 Input Source as "Others" in "Settings")

Method c: 12V/24V Car Charger/Storage battery(Set DC 2 Input Source as "Others" in "Settings")

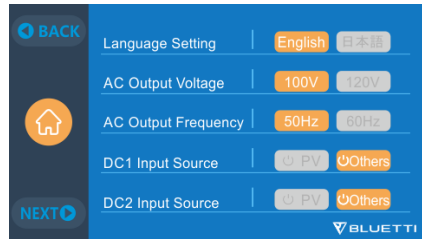
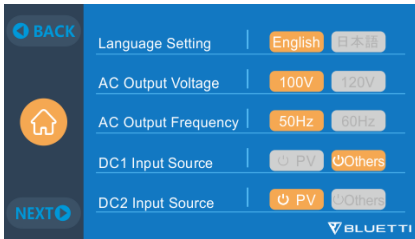

Method d: PV Parallel (PV parallel needs to be set in "Settings")

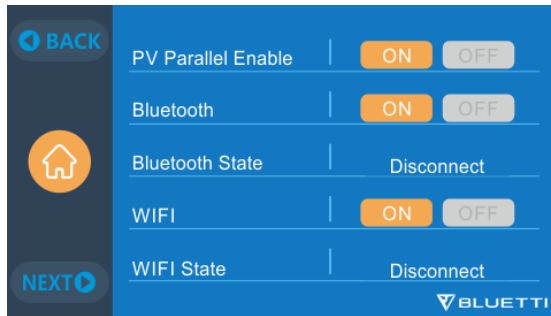

8.4. How to calculate the recharging time of EP500Pro

$5120\text{Wh} / \text{Total recharging power} + 0.5\sim 1\text{Hrs}$ (trickle charging time) = fully charging time estimation

Example: The total recharging power is 1100W(500W+600W) recharged by AC and 2nd adapter at same time, the estimation time will be 5.13-5.63Hrs.

09. Discharge (OUTPUT)

The operational time of the EP500Pro is subject to many different factors such as ambient temperature, discharge rate, remaining battery capacity, and other factors.

9.1. The Output Port

9.1.1. AC Output Port

- EP500Pro is equipped with *5 AC(US, JP version) / *3 AC(AU,EU,UK) outputs with a continuous 3000W Max. power of output in total, and the ability to support surges up to 6000W.
- Please make sure the combined power requirements of your appliances does not exceed the limit of each port.

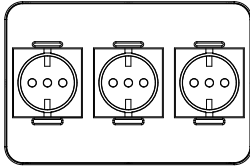

EU Version
3 * 220-240V/20A

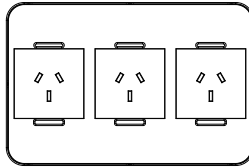

AU Version
3 * 220-240V/20A

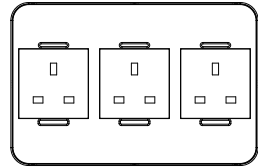

UK Version
3 * 220-240V/20A

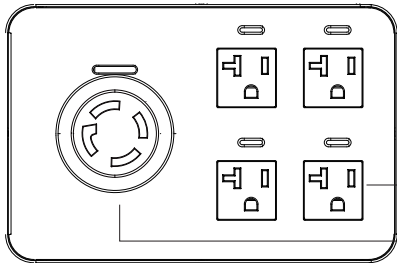

JP/US Version 100-120V/20A

4 Standard AC Receptacle 20A

1 L 14-30 Receptacle 30A

NOTE, The limit of power of output:
3000W for EU/UK/EU version and the L 14-30 receptacle of US/JP Version.
2000W for the standard receptacle of US/JP Version.

9.1.1. DC Output Port

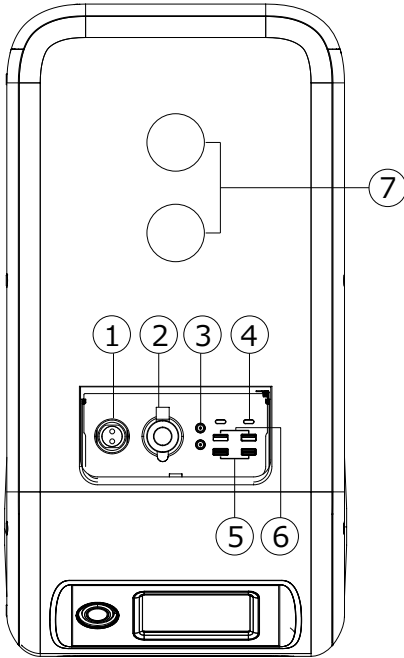

1. *1 RV port

Special 30A output port can be adapted to appliances widely, perfect for RV.

2. *1 Cigarette lighter port

Output port for devices with corresponding plug such as vehicle-use vacuum, mini refrigerator.

3. *2 DC 5521

Traditional ports for routers/cameras, old laptop etc.

4. *2 USB-C

Can be used via USB-C to USB-C cable to charge most devices in the market such as Pixel Phone, Macbook Pro at 100W Max.

5. *2 USB-A (fast charging)

Quick charge USB-A ports.

6. *2 USB-A

Classic USB-A ports.

7. *2 Wireless charging pad

Place your phone(if wireless charging supported) on the top of the EP500Pro vertically, and turn on the DC on homepage on screen.

9.2. Operation Time Estimation

● Kitchen Equipment



Refrigerator
700W(24h)
2.3 Days



Electric Fry Pan
1500W
2.7 Hrs



Microwave Oven
1000W
4.2 Hrs



Washer
500W(1000W)
4-7.66 Hrs

● Home Equipment



Space Heater
1500W
2.7 Hrs



Air Conditioning
8000Btu
1.6 Hrs



Smart Phone
18Wh
96 Times



Laptop
45Wh
59 Times



Desktop
300W
12 Hrs



CPAP
40W
64 Hrs

● Tools



Bench Grinder
1400W
2.9 Hrs



Welding Machine
1800W
2.3 Hrs



Circular Saw
1400W(2300W)
1.7-2.9 Hrs

● Transportation



Electric Vehicle(16A)
1800W
11.2-13.3 Miles



E-Bike
500W
7.6 Times

(The estimation operating time is only for reference)

9.3. How to Calculate the Operation Time

- $5120\text{Wh} * \text{DOD} * \eta / (\text{load } W) = \text{operation time (unit: hour/time)}$

If I want to know how many times 96W Macbook Pro could be recharged.

$$5120\text{Wh} * 90\% * 90\% / 96\text{W} = 43 \text{ times}$$

- What is the depth of discharge (DoD)?

To extend the battery-life, the power station set the 90% DOD, which means that only 90% of the battery capacity can be discharged. 10% of the energy is reserved to avoid damage to the battery due to over-discharge.

η indicates local inverter efficiency. $\text{DOD}=90\%$, $\eta =90\%$.

10. UPS

10.1. UPS Description

An uninterruptible power supply or uninterruptible power source (UPS) is an electrical apparatus that provides emergency power to a load when the input power source or mains power fails. A UPS differs from an auxiliary or emergency power system or standby generator in that it will provide near-instantaneous protection from input power interruptions, by supplying energy stored in batteries, supercapacitors, or flywheels.

10.1.1. FYI (For Your Information)

Battery SOC High indicates the limit of capacity the unit which can be charged by the grid. If you set the Battery SOC High to 80% in Customized Mode, the EP500Pro will be charged up to 80% from grid power. The remaining 20% will be charged via solar panels (PV). This allows a discharged EP500Pro doing UPS duties to quickly recharge from the grid when it comes back online to a certain percentage before switching to solar panels to insure there is ample power for the next power outage, but still charge via solar for clean and free energy.

10.1.2. UPS working system introduction

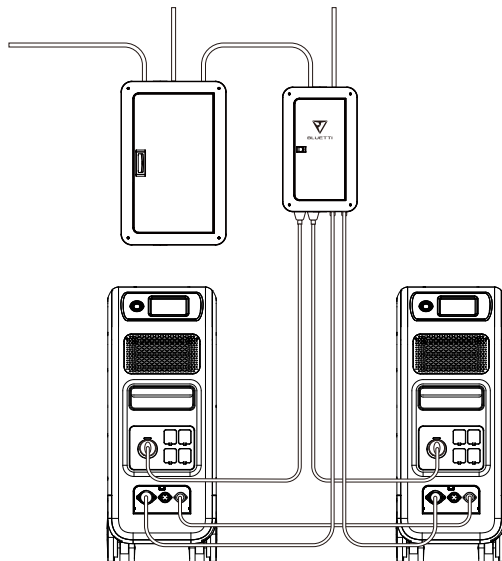

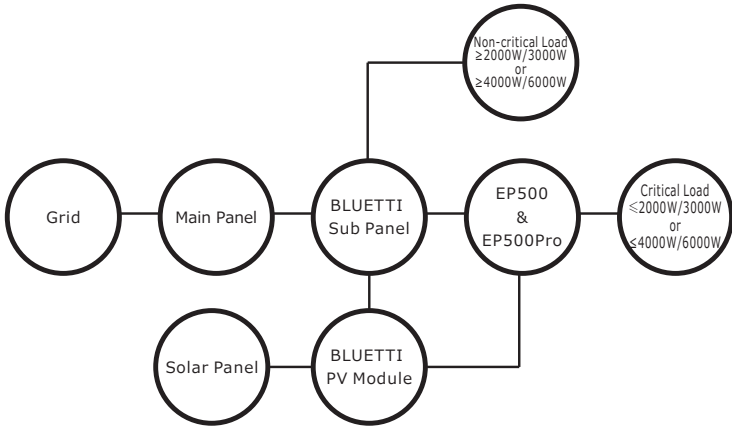

(EP500Pro grid-tied home power back-up system with Sub Panel and roof panels)

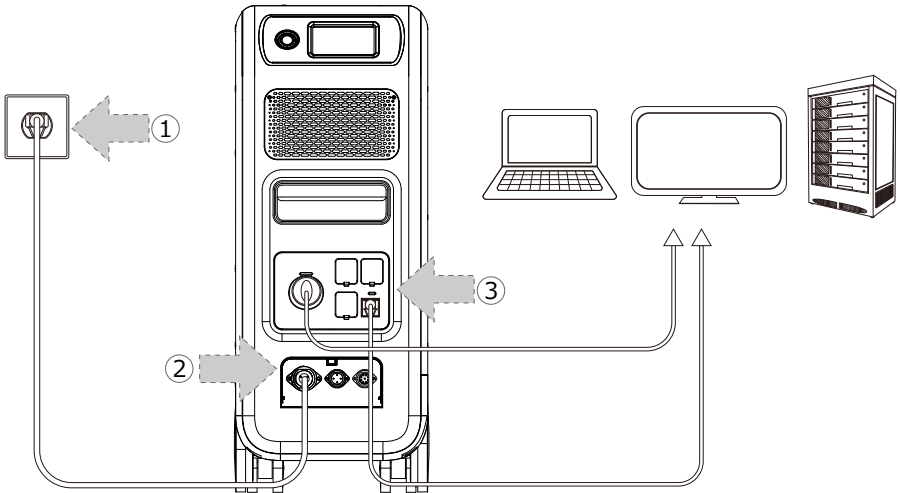

(Plug-in UPS system)

10.1.3. Turn On UPS Function

- Select "Setting" on the main touchscreen interface. Select "Next" and select "Working Mode" to choose UPS Mode.
- The default working mode is "Standard UPS Mode".



10.2. Enable UPS Running Mode

10.2.1 Standard UPS Mode

●Offline UPS: Basic UPS Working Mode

EP500Pro will power your load directly from the grid and maintain a 100% charge. When grid power fails, the EP500Pro switches to internal batteries.

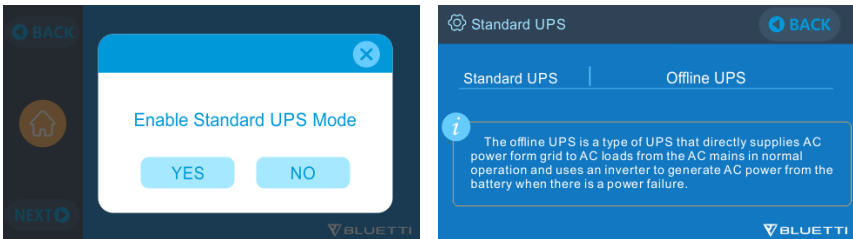

10.2.2. Time Control UPS Mode

●This allows you to set the times that EP500Pro will be charged via grid power and the times to run loads from its battery.

Charge Time: Set the time of EP500Pro when to be charged by grid to avoid the higher time-of-use electricity (peak) rates, normally set to off-peak times.

Discharge Time: Set the time to use the EP500Pro batteries to power the loads connected on AC output port of EP500Pro or Sub Panel (Optional Purchase). Usually set during peak-rate hours.

●Parameter Setting:

Battery SOC Low: When the remaining capacity of EP500Pro is under the preset Battery SOC Low state, the EP500Pro will stop powering loads connected to the AC output ports of the EP500Pro or Sub Panel (Optional Purchase).

Battery SOC High: The maximum capacity EP500Pro can be charged via grid. The remaining percentage will be charged either by solar (PV) or 2nd adapter.

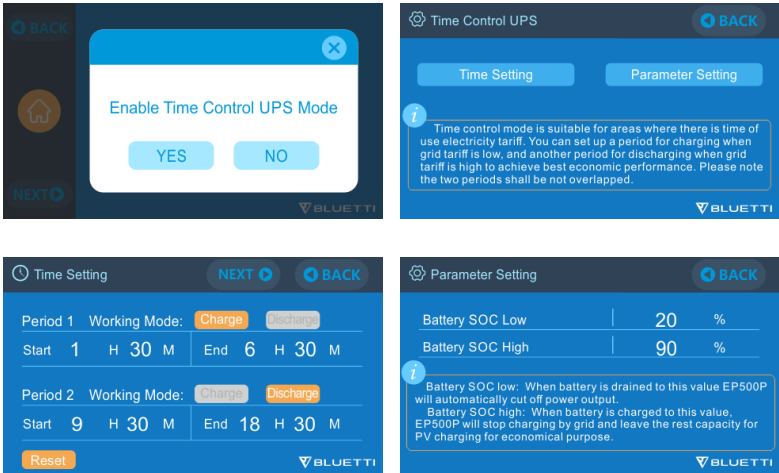

10.2.3. PV Priority UPS Mode

- **PV Priority Mode:** This mode is recommended for areas with stable grid power. The battery will be recharged mainly by PV for power savings.
- **Note:** In PV Priority Mode, EP500Pro can only be recharged via grid to 30% capacity, and also discharge to 30% of the capacity (you can tweak it to 100% for full grid charging manually on touchscreen or App) as the "Reserved capacity for PV charging". And rest of the capacity will be fully charged from either solar power or 2 adaptors.

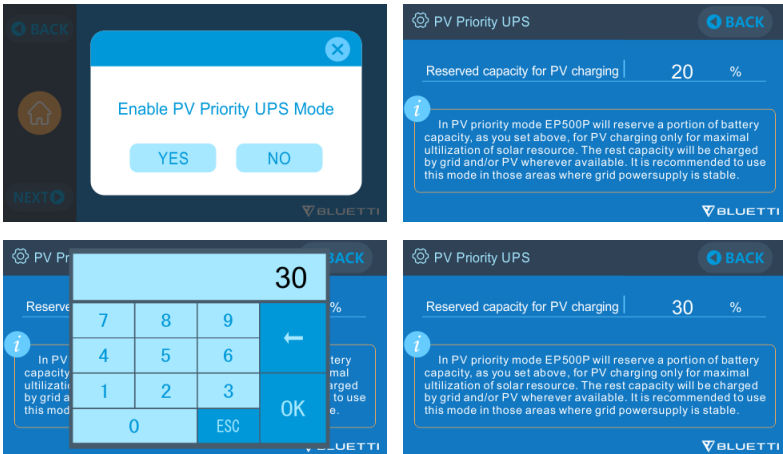

10.2.4. Customized UPS Mode

- Charge/Discharge time, and High/Low Battery SOC can be set in this UPS mode.
- Ability to disable the grid charging. The unit will not charge batteries from grid.
- Apart from Time Control UPS, the main switch of grid charging and time mode settings are involved. The setting of “Time Setting” and “SOC Setting” will take effect on both PV Priority Mode and Time Control Mode.

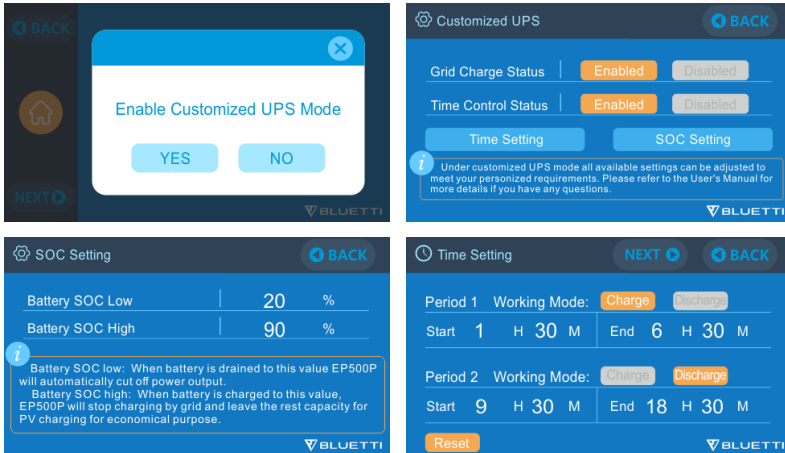

11. Split Phase Function

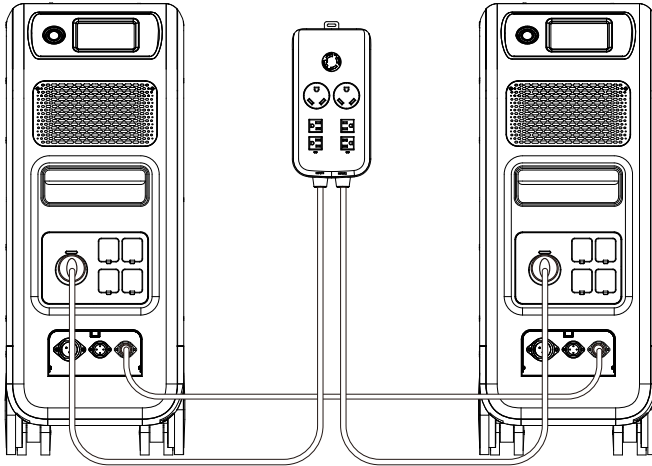

Note:

(1) Please disconnect the AC charging cable for both EP500Pro units while binding into split phase box.

(2) Certificated Technician is required to build the split phase system to power the Power Cabinet or Sub Panel.

Warning: If you insist to charge the EP500Pro which has been connected into split phase box already, please make sure the L1/L2/N wire is set at the right place or the EP500Pro will be damaged.

L: Live wire **N:** Neutral wire

- The “Machine Type” setting on screen is used to enable or disable Split Phase output. Split-Phase output is achieved by bonding two EP500Pro into one power system to double the available output power, voltage, and capacity.
- “Split Phase” is only used for connecting both *2 EP500Pro together (exclusive for the 100-120V version of the EP500Pro). A Fusion Box(P30A) is required (sold separately).
- Launch Split Phase Function:

Note: Only one touchscreen will be active when two EP500Pro units are connected.

If one of the EP500Pro is out of power, the Split Phase Bonding function will deactivate automatically.

Step 1: Plug the output cables from each of the two EP500Pro to the Split Fusion

Box Pro.

Step 2: Plug the communication cables from each of the two EP500Pro's to the Split Fusion Box Pro.

Step 3: Set the Machine Type to "Split Phase" on EP500Pro either.

Step 4: Select "Master" or "Slave" on the operating EP500Pro. Select "Master" will set the operating EP500Pro as the one to control both two EP500Pro. Select "Slave" will set the operating EP500Pro as the other EP500Pro as the "Master" one.



CONNECTION 1 (Standard Mode)

"Single Phase" is set as the default machine type if you are operating a single EP500Pro. This is the only and correct setting if a single EP500Pro is being used. Machine type is just used to set for Split Phase, "Split Phase" is only used for connecting both *2 EP500Pro (exclusive for 100-120V Version) bonded 2 pairs of EP500Pro to one power system to double the output power, voltage, so as to capacity. Please refer to Split Phase setting for detailed information.

CONNECTION 2 (Power Mode)

In Split Phase Power System, it is recommended that you choose our matching AC input cable. The AC input ports of the two machines are connected to L1,N,PE and L2,N,PE. Make sure that the phase of the two machines is correct. This AC Input Cable(Optional Purchase) is designed to match Split Phase System.

One end of the cable is connected to the NEMA L14-30 socket, and the other end is connected to the AC input interface of both two units through aviation plug. It must be ensured that the phase of the two machines is correct. The current capacity of AC input plug shall be $\geq 30A$.

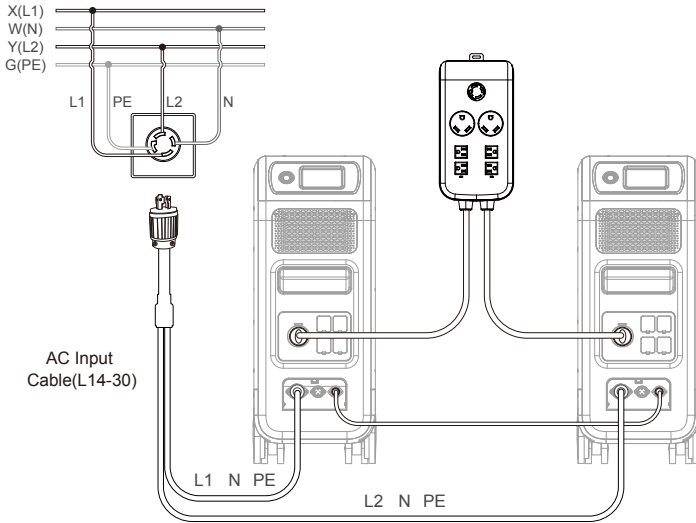

WRONG CONNECTION

It's forbidden to connect EP500Pro into Split Phase System when AC charging is ON, please use AC Input Cable(Optional Purchase) to charge both of your power stations in Split Phase System. Wrong Connection will damage the battery inside the power station and your warranty will be invalid.

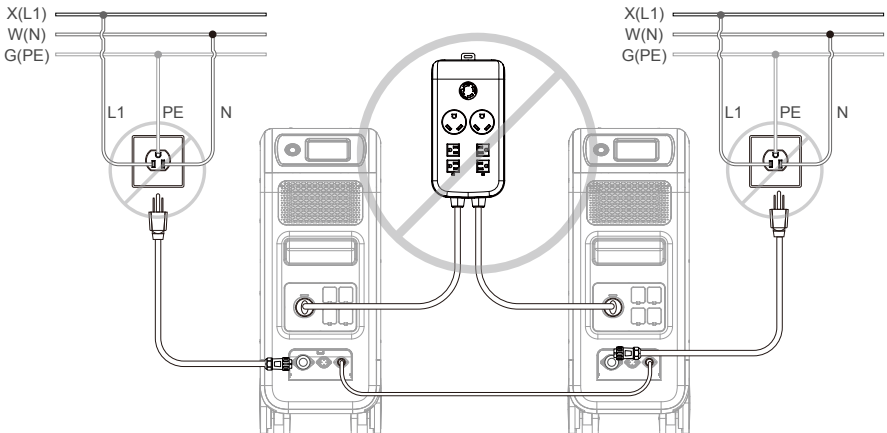

12. Technical Specification

Model	EP500Pro JP	EP500Pro US	EP500Pro EU/UK/AU
Net Weight	83kg (183.0lbs)		
Dimensions	580*300*760mm (22.8*11.8*29.9in)		
Charge Temperature	0-40°C (32-104 °F)		
Discharge Temperature	-20-40°C (-4-104 °F)		
Storage Temperature	-25-40°C (-13-104 °F)		
Working Environment Humidity	10-90%		
Certification	PSE, FCC, CE, UN38.3, msds, UL, SAA and ROHS		
Capacity	5120Wh (100Ah)		
Battery Type	LiFePO4		
Standard Battery Voltage	51.2VDC		
Battery Cell Voltage Range	44.8-57.6VDC		
Short-circuit Protection	Included		
Over-temperature Protection	Included		
MPPT	Built-in		
Over-temperature Protection			
Discharge Over- temperature	65°C		
Discharge Over- temperature Recovery	55°C		
Charge Over-temperature	55°C		
Charge Over-temperature Recovery	45°C		
AC Output			
AC Inverter	*5 3000W total		*3 3000W total

Rated Output Voltage	100VAC	120VAC	220-240VAC
Rated Output Frequency	50/60Hz		
Rated Continuous Power	3000W		
Rated Output Current	30A	25A	13A
Power of Over-load	3100W < load < 3750W, 2min; 3750W < load < 4500W, 5s; 4500W < load < 6000W, 500ms		
Efficiency	>88%		
THD	<5%		
DC Output			
Cigarette Lighter Port	*1 12VDC/10A		
DC 5521	*2 12VDC/10A		
USB-A	*2 5VDC/3A total		
USB-A(fast charging)	*2 3.6-12VDC/36W		
USB-C (Type-C)	*2 20VDC/5A; 5-15VDC/3A		
Wireless Charging Pad	*2 5W/7.5W/10W/15W		
RV Port	*1 12VDC/30A	418W>load, 2S	
Note: Cigarette lighter port shares 10A current with *2 DC5521 ports in parallel circuit.			
AC Input			
Input Voltage	85-110VAC/JP	102-132VAC/US	207-253VAC EU/UK/AU
Input Frequency	47Hz-63Hz		
Max. Input Current	30A		
Configurable Input Current	Preset at 15A, can be changed on screen		
AC Charging Voltage Range	90-264VAC		
AC Charging Frequency Range	47Hz-63Hz		
Power of Charging	3000W Max		
PV Input			

Max. Input Voltage	150VDC
MPPT Voltage Range	12-150VDC
Max. Power of Input	1200W*2
Rated Input Current	12A*2

13. Storage and Maintenance

- Please turn off the unit and charge it to 50-70% of capacity before storing.
- To help preserve battery health, please discharge and fully charge the unit atleast once every 6 months.
- Ensure proper ventilation when in use or in storage.
- Keep unit away from any combustibile materials or gases. (32-113 °F , 0-45°C).
A clean and dry environment is strongly recommended.
- Dry, non-abrasive cloths to clean the exterior from dust and debris every so often is highly recommended.
- Keep the unit away from children and pets.
- Do not stack anything on the top of the unit while in use or in storage.
- Avoid exposing the unit to rainy or wet environment and in direct sunlight.

14. Troubleshooting

Error Code	Error List	Troubleshooting
001	D-AMCU Warning	Please contact with the dealer if the error still exists after rebooting the unit.
002	D-BMS Warning	Please contact with the dealer if the error still exists after rebooting the unit.
003	D-A Communication Error	Please contact with the dealer if the error still exists after rebooting the unit.
004	Battery Voltage High -Hardware	Please contact with the dealer if the error still exists after rebooting the unit.
005	BUS Voltage High-Hardware	Please contact with the dealer if the error still exists after rebooting the unit.
006	SPS Voltage Low-Hardware	Please contact with the dealer if the error still exists after rebooting the unit.
007	Fan Warning-Hardware	Clean or replace the fan to ensure proper ventilation. Please contact with the dealer if the error still exists after rebooting the unit.
008	OCP (Over Current Protection)- Hardware	Please contact with the dealer if the error still exists after rebooting the unit.
009	LLC Soft-Start Failure	Please contact with the dealer if the error still exists after rebooting the unit.
010	BUS Soft-Start Failure	Please contact with the dealer if the error still exists after rebooting the unit.
011	H-BUS Voltage High	Please contact with the dealer if the error still exists after rebooting the unit.
012	Bus Voltage High	Please contact with the dealer if the error still exists after rebooting the unit.
013	LLC-Bus Voltage High	Please contact with the dealer if the error still exists after rebooting the unit.
014	Bus Voltage Low	Please contact with the dealer if the error still exists after rebooting the unit.

015	DC Input Voltage High	Please contact with the dealer if the error still exists after rebooting the unit.
016	DC Input Voltage Low	Please contact with the dealer if the error still exists after rebooting the unit.
017	DC Input Over Current	Please contact with the dealer if the error still exists after rebooting the unit.
018	Inverter Output Over Current	The output power of load exceeds. Please contact with the dealer if the error still exists after rebooting the unit.
019	Inverter Voltage High	Please check if the output of load meets the specifications of the unit. Turn on the AC after rebooting, please contact with the dealer if the error still exists.
020	Inverter Voltage Low	Please check if the output of the load meets the specifications of the unit. Turn on the AC after rebooting, please contact with the dealer if the error still exists.
021	Grid Input Over Current	Please check if the input of the current meets the specifications of the unit. Turn on the AC after rebooting, please contact with the dealer if the error still exists.
022	Inverter Output Short circuit	Please disconnect the load to make sure the load has been connected properly. Click to clear the alarm history.
023	Inverter Over-load Protection	Please disconnect the load to make sure the output power of loads meet the limit of the unit. Click to clear the alarm history.
024	Phase Integration Error	Check the input wire and whether the "Master" unit or "Slave" unit can work well.
025	AC Relay Short Circuit	Please contact with the dealer if the error still exists after rebooting the unit.
026	AC Relay Open Circuit	Please contact with the dealer if the error still exists after rebooting the unit.

027	Load Relay Short Circuit	Please contact with the dealer if the error still exists after rebooting the unit.
028	Load Relay Open Circuit	Please contact with the dealer if the error still exists after rebooting the unit.
029	INV Soft-Start Failure	Please contact with the dealer if the error still exists after rebooting the unit.
049	PV1 Over Current	Please contact with the dealer if the error still exists after rebooting the unit.
050	PV2 Over Current	Please contact with the dealer if the error still exists after rebooting the unit.
051	PV1 Over Voltage	Please check if the open circuit voltage of solar panels exceeds the input voltage standard of EP500Pro.
052	PV2 Over Voltage	Please check if the open circuit voltage of solar panels exceeds the input voltage standard of EP500Pro.
053	D-BAT Full	The battery is full.
054	D-BAT Drained	Empty of battery. When SOC > 5%, the alarm is cleared.You need to turn AC ON again on the screen.
055	Inverter Overload Warning	The output power of load exceeds.
056	AC Overload Warning	The output power of load exceeds.
057	Grid Voltage High	Please check whether the grid voltage fits the input voltage standard of EP500Pro.
058	Grid Voltage Low	Please check whether the grid voltage fits the input voltage standard of EP500Pro.
059	Grid Frequency High	Please check whether the grid frequency fits the input frequency of EP500Pro.
060	Grid Frequency Low	Please check whether the grid frequency fits the input frequency of EP500Pro.
061	Multi Communication Error	Please check whether the communication cable is connected correctly. Clear the alarm history or restart the unit.

062	Multi Address Error	Please check whether the communication cable is connected correctly. Please check whether the communication cable is connected correctly. Clear the alarm history or restart the unit.
063	Multi Synchronization Error	Please check whether the communication cable is connected correctly. Clear the alarm history or restart the unit.
064	Multi Brak Phase Error	Please check if the input of the AC voltage meets the specifications of the unit. Clear the alarm history or restart the unit.
065	PV Paralleling Error	Please check whether the PV parapllel enable setting is consistent with the PV input. Please contact with the dealer if the error still exists after rebooting the unit.
081	BMS Communication Interrupt	Please contact with the dealer if the error still exists after rebooting the unit.
082	LCD Communication Interrupt	Please contact with the dealer if the error still exists after rebooting the unit.
083	EEPROM Read & Write Error	Please contact with the dealer if the error still exists after rebooting the unit.
084	DSP Configuration Error	Please contact with the dealer if the error still exists after rebooting the unit.
085	RTC Read & Write Error	Please contact with the dealer if the error still exists after rebooting the unit.
086	12V/30A Port OCP	Please disconnect the appliances on DC 12V/30A ports. Clear the alarm history or restart the unit.
087	12V/10A Port OCP	Please disconnect the appliances on DC 12V/10A ports. Clear the alarm history or restart the unit.
088	USB/TYPER-C/PD Port Current High	Please disconnect the appliances on USB ports. Clear the alarm history or restart the unit.

089	DC12V/30A Output Current High	Please disconnect the appliances on DC 12V/30A ports. Clear the alarm history or restart the unit.
090	DC12V/10A Output Current High	Please disconnect the appliances on DC 12V/10A ports. Clear the alarm history or restart the unit.
091	DC Output Soft Start Failure	Please contact with the dealer if the error still exists after rebooting the unit.
092	DC12V/30A Output Short Circuit	Please disconnect the appliances on DC output ports.
093	DC12V/10A Output Short Circuit	Please disconnect the appliances on DC output ports.
094	USB/TYPE-C/PD Port Locked	Please disconnect the load to make sure the output power of loads meet the limit of the unit. Please contact with the dealer if the error still exists after rebooting the unit.
095	12V/30A DC Port Locked	Please disconnect the load to make sure the output power of loads meet the limit of the unit. Please contact with the dealer if the error still exists after rebooting the unit.
096	12V/10A DC Port Locked	Please disconnect the load to make sure the output power of loads meet the limit of the unit. Please contact with the dealer if the error still exists after rebooting the unit.
097	BMS Temperature Abnormal	Please store EP500Pro at the recommended temperature and leave it until the temperature inside back to the normal standard.
098	BMS Over Voltage	Please contact with the dealer if the error still exists after rebooting the unit.
099	BMS Low Voltage	Please contact with the dealer if the error still exists after rebooting the unit.
100	BMS Over Current	Please contact with the dealer if the error still exists after rebooting the unit.
101	BMS Precharge Error	Please contact with the dealer if the error still exists after rebooting the unit.

102	BMS Output Short Circuit	Please contact with the dealer if the error still exists after rebooting the unit.
107	NTC Faulty	Please leave the unit at the recommended temperature few hours to recover. Please contact with the dealer if the error still exists after rebooting the unit.
108	Fan Faulty	Clean or replace the fan to ensure proper ventilation. Please contact with the dealer if the error still exists after rebooting the unit.

15. FAQ (Frequently Asked Questions)

- How to claim the warranty and extended warranty?

Please place your after-sale requirement as the warranty card written to the vendor where you order the product, the extended warranty(if purchased) will take effects after the default warranty is void.

- Can it be upgraded?

The firmware including ARM, DSP, IoT and BMS can be upgraded online through OTA, and the parameters of the machine will be adjusted and optimized.

- Can it be charged and discharged at the same time?

Yes, the unit supports pass-through charging function for both AC and DC outputs. We recommend to fully charge the unit at least once per month to extend battery life.

- How many UPS modes are there?

There are 4 types of UPS Mode you can choose freely, Standard UPS, Time

Control UPS, PV Priority UPS and Customized Mode.

● What is the UPS switching latency?

20ms from offline UPS.

● Can I connect my two EP500Pro with Fusion Box to achieve double the output power, voltage and capacity.

You can connect two EP500 OR two EP500Pro with a Fusion Box. The units must be of the same type and the correct Fusion Box (P020A for EP500, P030A for EP500Pro). You cannot mix a EP500 and EP500Pro with a Fusion Box.

● Can I use third-party solar panels to charge the unit?

Yes, the third-party solar panels are available as long as they contain MC4 connectors, besides the voltage (in series or parallel) is between 12V to 150V and the maximum input power is 2400W.

If the open circuit voltage of the panels is less than 550V, you can choose PV Module to step down the voltage to achieve solar charging.

● How do I know whether my appliance can work well with the power station?

Calculate how much the continuous loads are for your appliances are in total. As long as they do not exceed the rated output power of the power station, it should work.

● How can I connect the product to my home circuit breaker box?

To install the grid-tie power system, an electrician with a professional technician certificate is required, connect the wires of critical equipment from your main electrical box to the BLUETTI Sub Panel (optional purchase).

16. Declaration

- Some changes may not be noticed specifically such as appearance or specifications due to the exterior material or hardware improvement of the product.
- Our company shall not be liable for any damage caused by force majeure such as fire, typhoon, flood, earthquake or the user's intentional negligence, misuse or other abnormal conditions.
- No compensation for damages shall be made for utilizing non-standard adapters and accessories.
- Our company will not bear all responsibilities if the damage is caused by not operating the product properly according to the use method in operation manual.
- This unit is not suitable for use on the relevant equipment or machines involving:
Personal safety, such as atomic energy devices, aerospace devices, transportation devices, medical devices, etc., or any equipment or machines that require highly reliable power sources. We are not responsible for accidents, fires, or wrongful or negligent actions done to the machine and equipment which results in damage.

